

Thank you for purchasing TAIKOLLER. Please read this manual carefully before use.

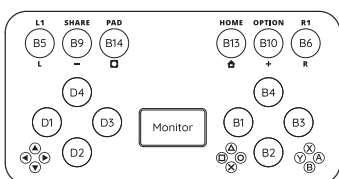

Product List

- TAIKOLLER Game Controller 1
- Instruction Manual 1
- USB-A to USB-C Cable 1
- Bracket (Left) 1
- Bracket (Right) 1
- Bracket screws 4

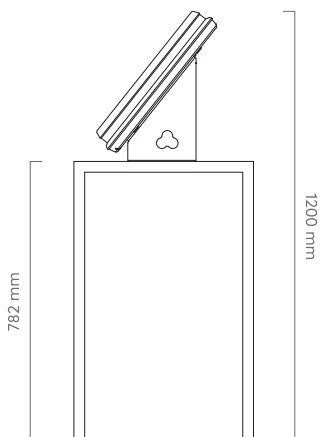

Mode Switch

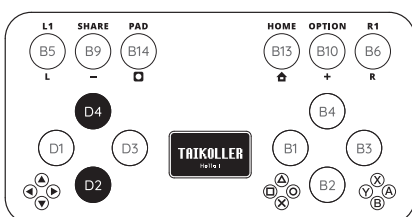

Press ↑ and ↓ at the same time and hold for more than 3 seconds. The monitor will show the mode selection.

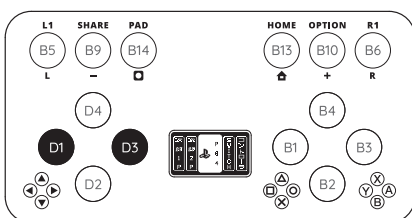

Press ← or → to find the mode you need.

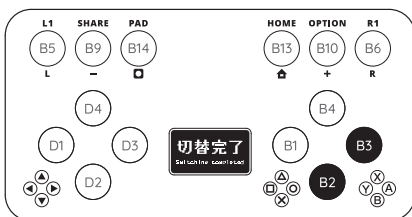

Press X/B or O/A to confirm.

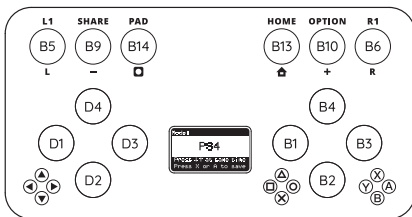

In standby mode, the screen will display the current mode.
Tips: Press ↑ and ↓ at the same time to enter the state of switching modes. Press X/B or O/A to switch to the corresponding mode.

More features may be added in the future, follow us on [Twitter @GamoTwo](#).

TAIKOLLER Options

TAIKOLLER Options provides the following functions:

- ① Switch TAIKOLLER mode.
- ② Set the trigger threshold to match the strength of hitting.
- ③ Set custom minimum output interval in different modes.
- ④ Set custom wallpaper you prefer.
- ⑤ Firmware upgrade.



Please visit dj-dao.com/en/support to download and view manual.

Connection

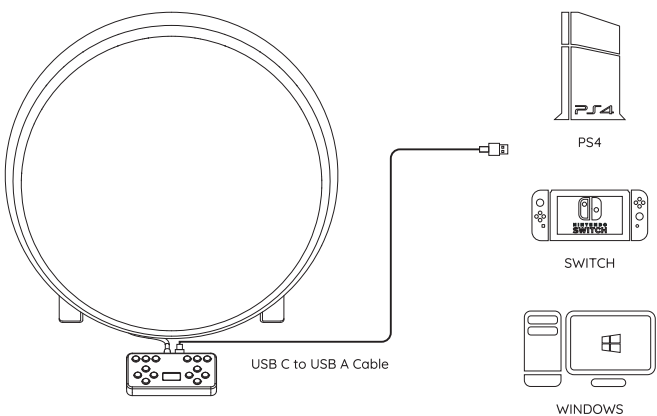

Caution !!

It is not recommended to use **USB-HUB**, if you must use it, please use **USB-HUB** with independent power supply. It is recommended that the **USB-C** cable be connected to the **USB** port on the motherboard of the computer.

Attention

- ※1. If the TAIKOLLER is not working properly, please connect the **USB-C** cable to the **USB** port on the motherboard of the **PC**, there will be enough power supply.
- ※2. It is not recommended to use **USB-HUB**, if you must use it, please use **USB-HUB** with independent power supply.

For the latest firmware upgrade, please visit: dj-dao.com/en/support

Warranty period: 180 days from delivery date

GAMO2 warrant that we will comply with this aftermarket terms, and it doesn't cover the accessories of this product.

- Within 1-7 days, whatever problem happens, GAMO2 will provide free maintenance, free replacement, and bear the shipping cost.
- Within 8-30 days, only in the case of normal use, we will provide free maintenance, free replacement. The shipping cost need to be born by the customer.
- Within 31-180 days, we will provide technical support via email, and free maintenance. The cost for replacement and shipping need to be born by the customer.
- If it were beyond 180 days, we only provide technical support via email. The other cost need to be born by the customer.

This warranty doesn't cover following cases, and GAMO2 will provide paid maintenance service.

- Doesn't provide order number when asking for maintenance.
- Second-hand products.
- The failure/damage caused by fire, earthquake, flood, public nuisance, lightning strike, salt injury and the other natural disasters.
- The failure/damage caused by dropping or impacting this product during the shipment, movement.
- The failure/damage caused by wrong connection method, or the operation not in accordance with the guide.
- The failure/damage caused by the operation not in accordance with the notices.
- The failure/damage caused by unauthorized modification.

[@gamotwo](#)

sales@gamo2.com

Layout

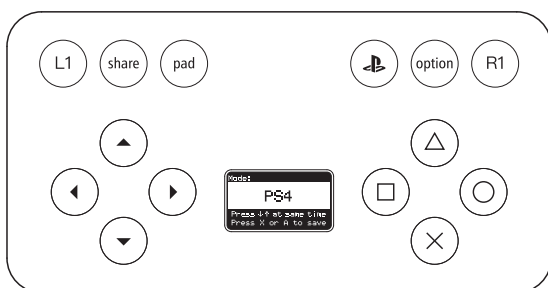

PS4 mode (default mode)

- ① After connecting to **PS4**, you need to press the **PS** button to activate the current controller.
 - ② Game Settings → Operation Type → Type 4
- ※ pad : Touch button

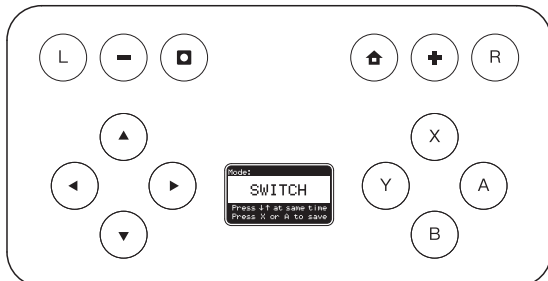
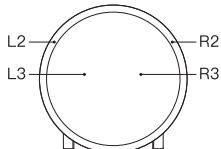

Switch mode

- ① Please turn on the wired connection of the **Pro Controller**.
- ② Game Settings → Operation Type → Type 4

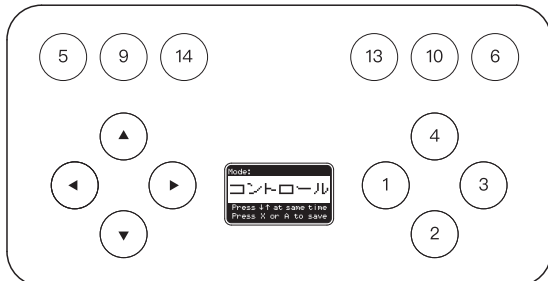
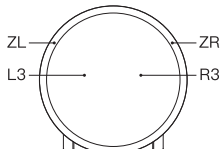

Controller mode

It is recommended to use it when playing **TJApayer** or **Opentaiko**.

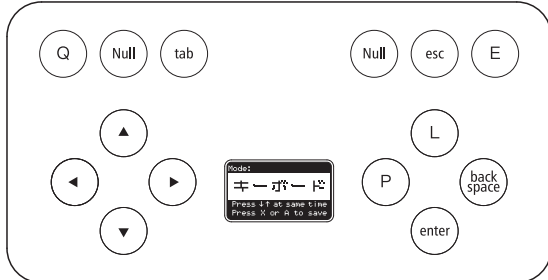
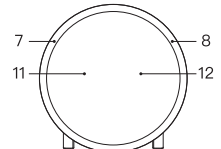

Keyboard mode

- ① It is recommended to play the **Xbox** version of **The Drum Master** running on **windows**.
- ② The button values on the controller are optimized for **The Drum Master** on **windows**.
- ③ You can also play any game that supports a keyboard.

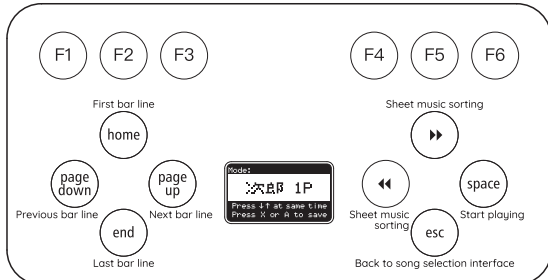
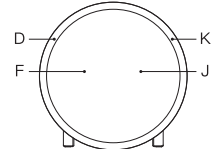

Jiro 1P mode

- ① Map the commonly used functions of **Taiko Sanjiro** and **Taiko Sanjiro 2** to the buttons of the controller.
- ② The output values of **1P** mode are **D, F, J, K**.

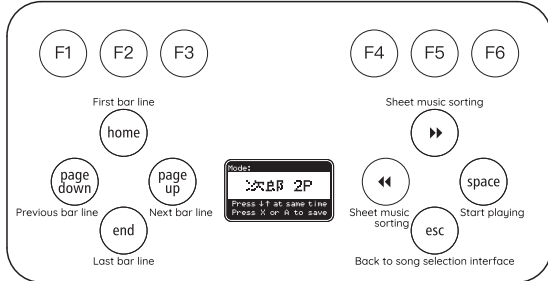
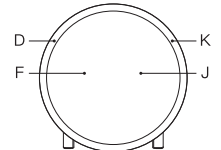

Jiro 2P Mode

- ① Map the commonly used functions of **Taiko Sanjiro** and **Taiko Sanjiro 2** to the buttons of the controller.
- ② The output values of **2P** mode are **C, V, M, <**.

